

Electric Powered
**AERIAL WORK
PLATFORMS**





LARGE ROTOBLAST ROOM (LRR)

E300AJ

JLG

Think Orange to Stay Green.

Today, more people are demanding environmentally-friendly equipment. More municipalities are demanding “green” building for new construction and renovations. The JLG® line of electric powered aerial work platforms are the green machines in the lift industry.

JLG electric powered aerial work platforms feature longer run time, greater uptime and higher productivity. The energy efficient electric drive boosts your productivity with industry-leading duty cycles.

The efficient machine design means less scheduled service, a quieter work area, less dependency on hydraulic oils, and zero emissions.

From job start to completion, 12 ft to 60 ft, scissor lift, boom lift or mast lift, JLG has an electric lift to meet your needs and keep your job green.



Ready to Work Overtime.

Experience the benefits of reduced charging time and longer runtime with ES Series scissor lifts. You can stay on the job longer, getting more work done in one day.

With only two hoses and four fittings, you're working with a cleaner machine that decreases scheduled service requirements and reduces that chance for leaks.

Up to 1,000 lb capacity, proportional controls for ease of operation and optional accessory packages give you exactly what you need to get the job done.



Longer runtime

On a single charge, the electric drive delivers more than double the battery life of hydraulic drive machines.



One-Handed Operation

Fully proportional drive and lift control is smoother and more efficient.

Narrow or Wide Platforms

The 1930ES, 2030ES and 2630ES feature 30-inch narrow platforms for access through standard doorways. The 2646ES and 3246ES provide a 46-inch platform for more workers, tools or supplies.

Two-Piece Brake Cover

Corrosion-resistant brake assembly extends life of brakes and lowers operating costs.



ES Series ADVANTAGES

- Lower cost of ownership.
- Exclusive application-specific accessory packages.
- Larger platforms and higher capacities.
- Three 30 in. (76 cm) wide models fit through narrow doorways and aisles.
- Automatic posi-traction.



Drive Motor Cable

Improved to provide strain relief and consistency when routed during services.

Dual Capacity

The 2630ES and 3246ES are rated for dual capacity. Restricted capacity on the 2630ES is 500 lb, and unrestricted is 800 lb. The 3246ES features 700 lb restricted and 1,000 lb unrestricted capacity.



On-board Fault Code Display

Get instant feedback on the status of your machine. An on-board display provides a visual indicator without the need for the analyzer, reducing troubleshooting time.



Platform Cable

An efficiently placed cable, secured with plated steel fasteners, doesn't interfere with operator's work.



Deck Extension

Redesigned to keep debris from interfering with the extension.



Cast Wheels

Thicker, heavier cast wheels are even more resistant to abusive operation.



Smarter Design Reduces Operating Costs

Only two hoses and four fittings mean fewer leaks, improved reliability and reduced scheduled service requirements.



Easy Access

Slide-out battery trays with steel covers are one of many features to facilitate servicing.



Built from corrosion-resistant, high quality aluminum, the deck features non-skid strips for less slip and more grip for the operator.



LE Series

LARGE ELECTRIC SCISSOR LIFTS

Outstanding Performance, On Slab and Off.

Handle a wide variety of terrain, without noise and fumes. With the standard oscillating axle, 35 percent gradeability, rugged all-terrain tires and available all-wheel drive, you'll be able to go off the slab and into the mud with the LE Series scissor lifts.

Both models will fit through standard double doorways to get you to and from the work site.

The efficient direct electric drive system gives you the muscle you'll need for demanding jobs; and you'll get double the duty cycles of other electric scissors with the deep cycle batteries.



Full-time automatic traction control and an oscillating axle boost off-slab productivity.



LE Series

ADVANTAGES

- Double the duty cycles of competitive electric scissor lifts.
- All-wheel drive provides superior performance indoors or out.
- 1,000 lb capacity (3369LE), 800 lb capacity (4069LE) on the platform and 250 lb on the platform extension.
- Zero emissions and quiet operation for sensitive environments.
- Multi-power option features an on-board diesel-powered generator with improved fuel efficiency for lower costs.
- QuikCharge GenSet option automatically charges your lift for continuous operation.
- Platform heights of 33 ft (3369LE) and 40 ft (4069LE) provide working heights of 39 ft and 46 ft respectively.

Compact. Powerful. Productive.

The ultra-compact 1230ES mast lift is compact enough to fit in a freight elevator and lightweight enough to be used on weight-sensitive floors. Charged and ready to go, the super-efficient electric drive keeps you on the job longer, increasing your uptime and giving your productivity a lift. With 500 lb capacity, the 1230ES has the muscle to carry you and your gear, even at full height.

With a super-efficient electric drive, the 1230ES has longer runtime than any lift in its class. No chains, cables or rollers in the mast lowers maintenance requirements and operating costs. Keep your work environment clean; with only four hoses, you greatly reduce the chance for hydraulics leaks.



98% Cleaner
Fewer hoses and couplings mean fewer potential leak points.



Saloon Gate
Saloon-style swing gate for ease of entry and exit.



Tool Tray
The workstation includes tool and fastener tray, 110V AC outlet and one-hand controller operation.



Serviceability

- All-steel swing-out battery doors have heavy-duty hinges.
- Rugged design and strong 12 ft mast provide durability.

1230ES ADVANTAGES

- Raises or lowers in 12 seconds for increased productivity.
- Five-inch turning radius for tight workspaces.
- No chains, cables or rollers in the mast to maintain or replace.
- Heavy-duty steel wheels with non-marking rubber for a cushioned ride.

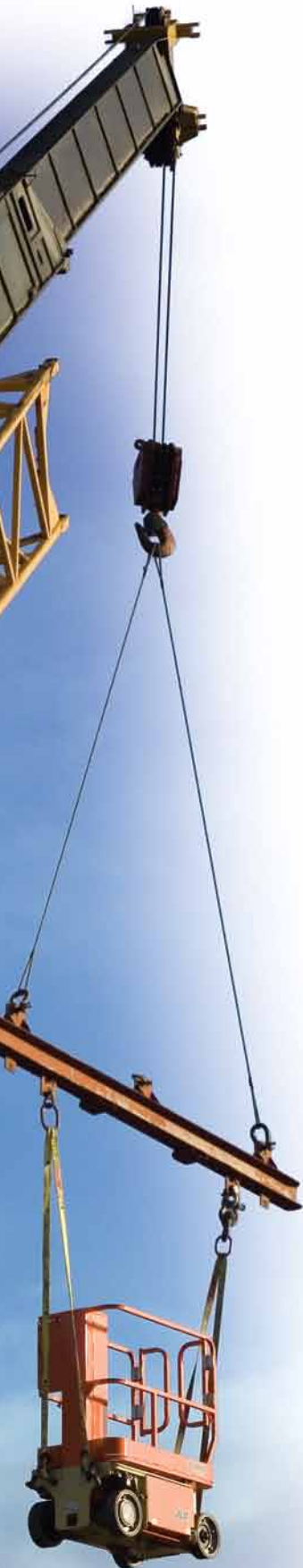

Toucan® Series
MAST-STYLE BOOM LIFTS

Puts Hard to Reach Within Reach.

With the JLG Toucan® vertical mast lift, you can meet your overhead challenges head-on. Work up, over and around assembly lines, shelving, ductwork or partitions more easily and without interferences. Positioning is easier with a 360-degree rotating mast, up to 33 ft of lift height and over 14 ft of jib reach. With its 500-lb capacity and a long running electric powered drive,* the Toucan will help you boost productivity hour by hour, year after year.

BUILT TO TAKE ON YOUR FACILITY CHALLENGES

Plant maintenance, retooling and changeovers, warehousing, inspection and remodeling, general contracting—you can count on the Toucan Series to help keep production moving.

AS VERSATILE AS YOUR NEEDS

With thick rubber non-marking tires for extra cushioning, clean and efficient electric power and 25% gradeability,* you're equipped better than ever to meet your access challenges. Smooth proportional controls, a narrow chassis and greater horizontal outreach are just some of the features that come standard and help you get the job done with greater speed and efficiency.



*Not applicable to Model E33MJ

Toucan® Series ADVANTAGES

- Compact dimensions for accessing hard-to-reach areas.
- Versatile articulating jib provides up to 14 ft 6 in. (4.42 m) of horizontal reach and up to 23 ft 6 in. (7.16 m) of up and over reach.
- 360-degree rotating mast for unmatched positioning capabilities.
- Capacity for two workers and supplies.
- Long-lasting, environmentally-friendly electric power.



Turn the Corner on Productivity.

The E Series boom lifts are environmentally friendly with industry-leading performance. You can select from three platform heights and chassis widths to best suit your work environment. With the optional articulating jib, you'll have even greater access to hard-to-reach places.

ROUND THE CLOCK PERFORMANCE

The E Series will keep you on the job up to 50% longer than the competition with industry-leading duty cycles. The Multi-Power option gives you round-the-clock operation and faster battery charging with the QuikCharge GenSet Automatic Charging System.

MANEUVERABILITY. INSIDE AND OUT.

With automatic traction control, both drive wheels work independently for improved traction on uneven surfaces.



E300, E400 & E450 Series ADVANTAGES

- 500 lb (227 kg) platform capacity.
- Choice of standard or narrow chassis.
- Industry-leading duty cycles.
- Exclusive JibPLUS® boom option provides 180-degree range of side-to-side movement.
- Zero emissions and low noise.

E600 Series
ELECTRIC ARTICULATING BOOM LIFTS

Clean and Green, 60-ft Machine.

The E600 Series gives you the most height in an electric powered boom lift. With four configurations, you can choose from electric or multi-power, standard articulating or articulating with JibPLUS.®

You can work on slab or off, without hesitation with the non-marking all-terrain tires. With the Automatic Traction Control, optional all-wheel drive and standard oscillating axle, you won't need to be shy about travelling over rough terrain.

Whether your jobs include industrial applications, maintenance, construction, or anything in between, the E600 Series delivers with zero emissions and reduced noise levels.

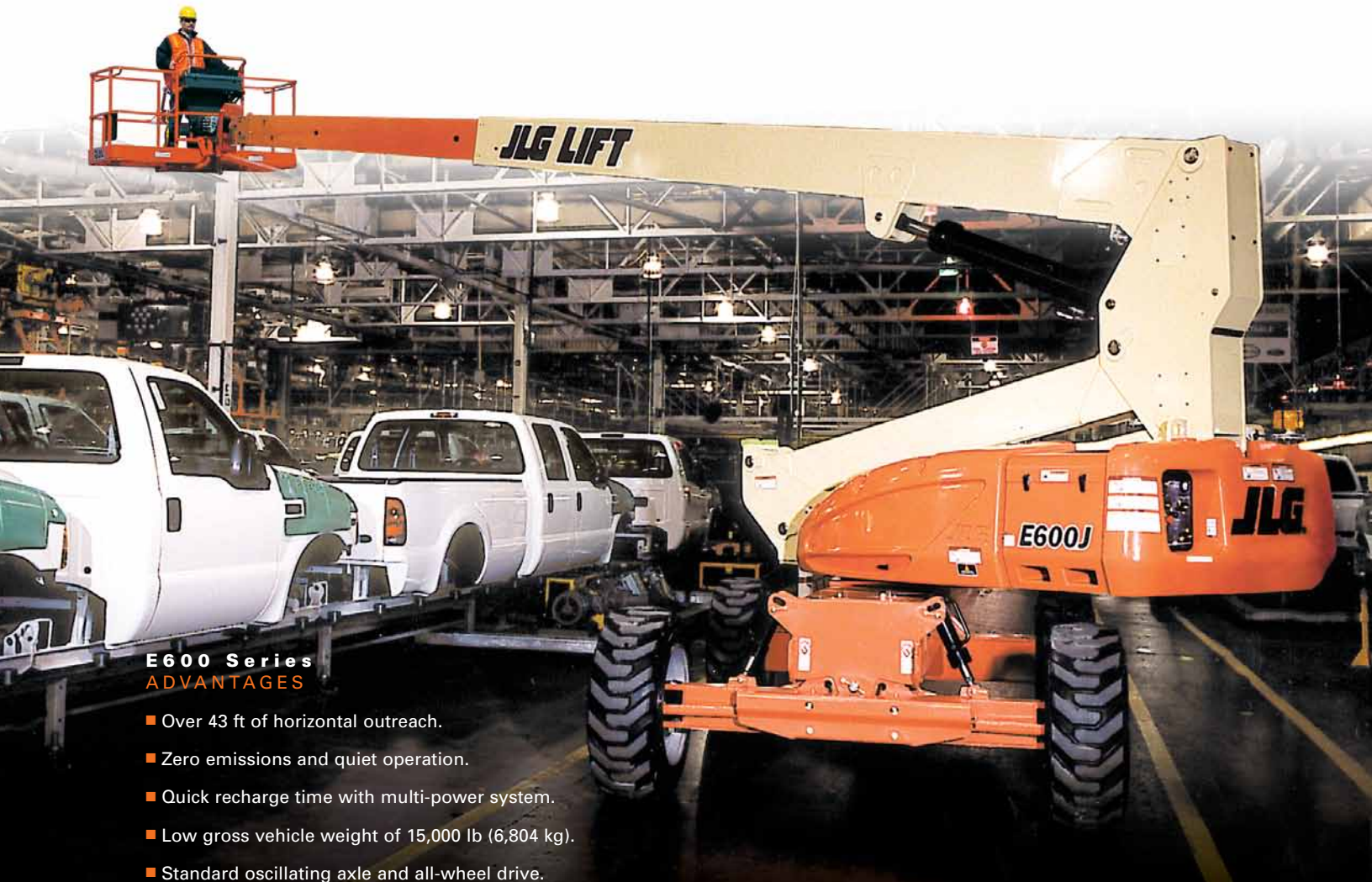

E600 Series
ADVANTAGES

- Over 43 ft of horizontal outreach.
- Zero emissions and quiet operation.
- Quick recharge time with multi-power system.
- Low gross vehicle weight of 15,000 lb (6,804 kg).
- Standard oscillating axle and all-wheel drive.

Operator-friendly controls have one-touch outrigger leveling and interactive display in platform.



Reach What Others Can't with JLG® Compact Crawler Booms.

Now you can go more places around the job site thanks to the low weight and rubber tracks on the new Compact Crawler Boom. With three models available with working heights ranging from 45 ft to 75 ft, JLG Compact Crawler Booms feature a tracked wheel carriage that climbs steps and a narrow chassis for access through gates, yards, standard doorways and public buildings.

Compact Crawler Series ADVANTAGES

- Compact design increases ease of transport
- Enhanced maneuverability and accessibility
- Environmentally friendly -- electric and combustion combination power for efficient energy usage
- Outriggers required for operation and provide leveling capability
- Lightweight for low floor loading and ease of transport



Photographs depicted in this publication are for illustrative purposes only. Any products, decal or other details depicted are subject to change or modification at the manufacturers discretion.

Tow-Pro® Series
ELECTRIC ARTICULATING BOOM LIFTS



Innovative Controls
Detachable platform controls provide faster and more efficient boom positioning with one-hand operation of all boom functions.



Easy Access
The articulating jib on the T500J gets you into those hard-to-reach places.

Tow-Pro® Goes Wherever You Go.

The Tow-Pro® Series lets you tackle the same jobs as the other JLG® electric boom lifts, with an easier option for transportation. With the standard combination hitch, industry-leading towing speed and hydraulic auto-leveling outriggers, you can have the Tow-Pro to the job site and working in no time.

You can tackle a variety of jobs including residential maintenance, construction, pressure washing, tree trimming, exterior painting and maintenance tasks. Two models offer platform heights of 35 ft or 50 ft, and both have a 500 lb capacity for you and your tools.

More Rigidity
The proven telescopic boom has a more rigid platform feel, allowing for improved worker confidence.



Optional Generator
An accessory mounting tray accommodates a generator, air compressor or pressure washer.



Tow-Pro Series
ADVANTAGES

- 35 ft (10.67) and 50 ft (15.24 m) models.
- Hydraulic auto-leveling outriggers for faster and easier setup.
- Industry-leading 65 mph (105 kmph) rated towing speed.
- 24V DC electric or gas-powered engine.
- Standard air and water lines to the platform.

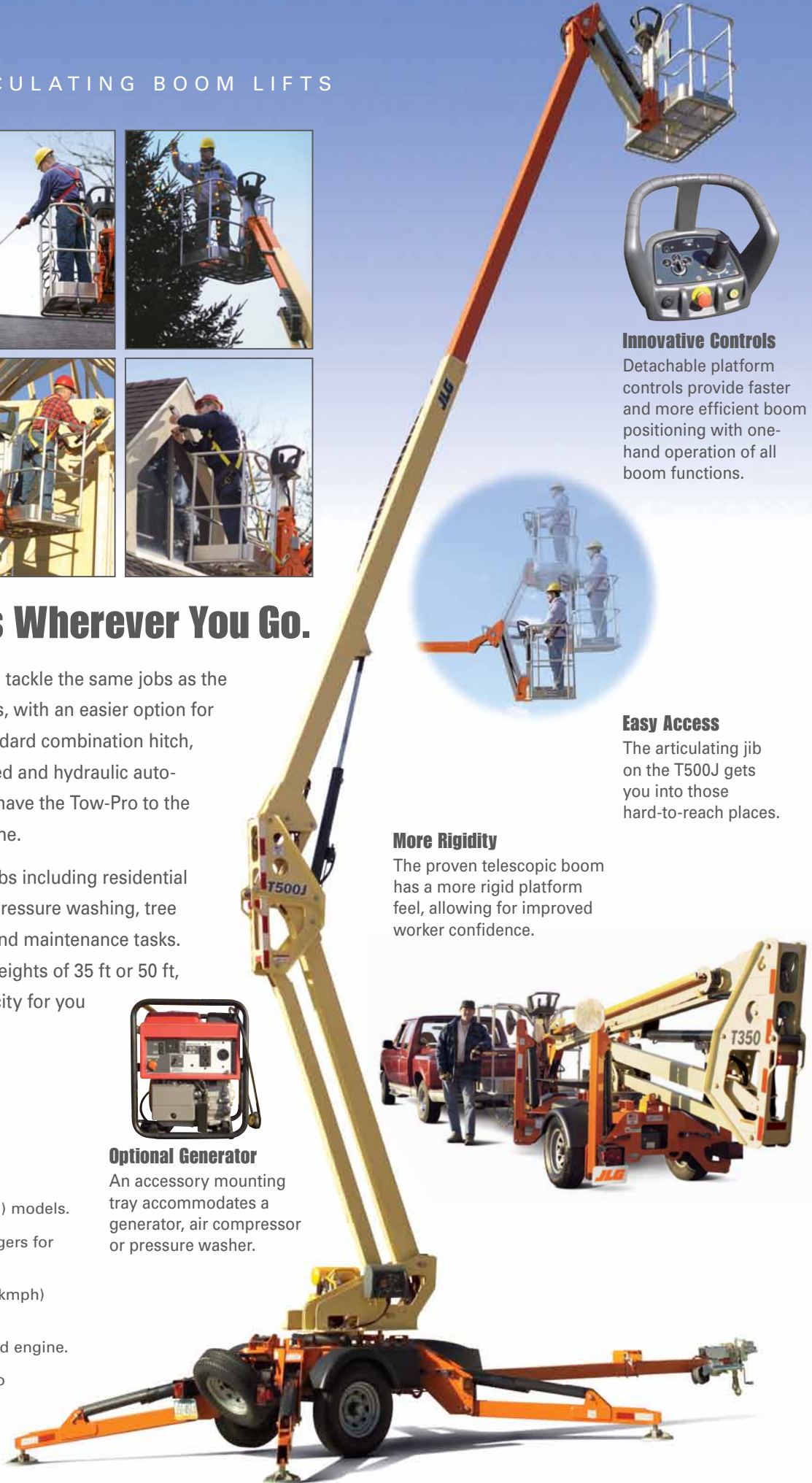

Putting Your Work Above Everything.

When it comes to JLG® Ground Support, it's all about you. Your productivity. Your profitability. Your uptime. From the purchase of your first piece of equipment straight through to the training, parts and maintenance that follows.



Customer Service Call Center

You can be assured we'll be giving an all-out effort to support you. Just think of us as your personal on-call, full-service support team. We make it happen. Period.

Aftermarket Parts

Keep your equipment running at peak performance with genuine replacement parts, accessories, attachments, rebuilt and competitive parts all from one source—JLG.



Financial Solutions

Maximizing your profits. Preserving your cash flow. Let our financing specialists help choose the program designed specifically for your needs.



Training

Knowing your equipment inside and out results in higher productivity on the job. Our instructor-led courses give you the hands-on time you need for success.

Service Centers

Your needs. Your uptime. JLG is on the job to fulfill your every need, from repair, reconditioning, same-day parts and much more. We're here to support you.



Workstation in the Sky® Series
ACCESSORIES

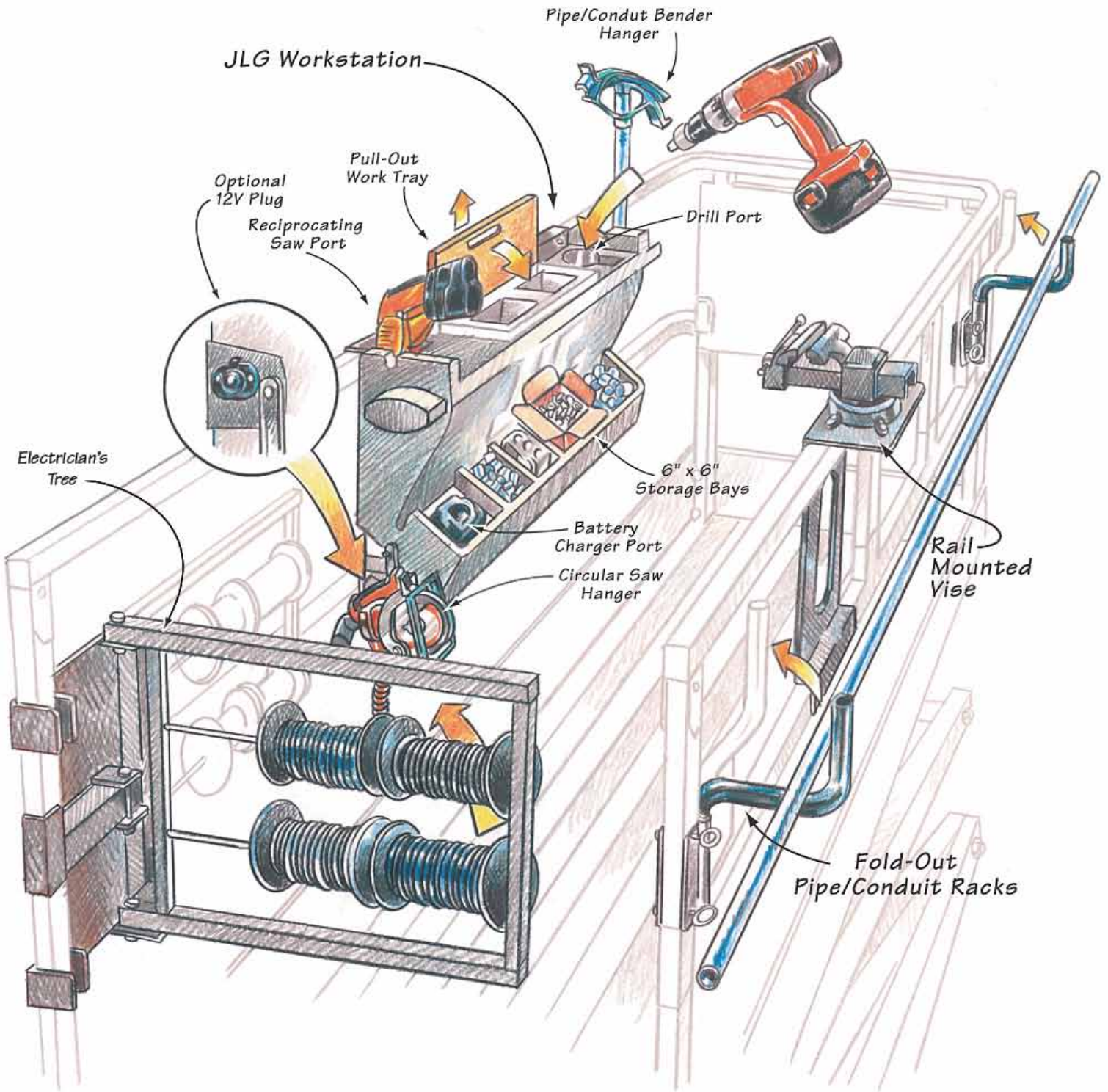

Optional Workstation in the Sky® accessory packages are designed for the specific needs of electricians, plumbers, contractors and plant maintenance professionals.

Accessories that Extend Your Scissor Lift's Versatility.

Workstation in the Sky® accessory packages are designed to keep your tools and components within arm's reach. Choose from packages that feature a removable workstation that optimizes platform space with compartments for tools such as a reciprocating saw, drill, circular saw, battery charger and six-inch by six-inch component boxes. Plus, a pull-out tray is included to provide a flat working surface near the top of the rails.



ELECTRICIAN'S PACKAGE

For electrical contractor applications that require battery-powered tools, the JLG® workstation keeps your tools within reach and off the floor of the platform. A stowable workbench and molded pockets provide ample storage while leaving the workspace open to get the job done. Electrician's Tree carries six 500 ft wire spools to speed up wire pulling and reduce friction associated with ground-based wire trees.

PLUMBER'S PACKAGE

Manufacturer-approved pipe racks provide positive retention of materials for plumbing contractors, while storage outside the platform helps prevent rail damage and optimizes space.

PLANT MAINTENANCE PACKAGE

The Plant Maintenance Package combines popular elements of the Electrician and Plumber packages to help plant maintenance professionals perform tasks, ranging from general repair to electrical and mechanical installation. In addition, a small welder powered by the machine batteries is included for light repairs.

ES SERIES ACCESSORIES					
	1930ES	2030ES	2630ES	2646ES	3246ES
Electrician's Package	N/A	N/A	N/A	•	•
Plumber's Package	N/A	N/A	N/A	•	•
Plant Package	N/A	N/A	N/A	•	•
Workstation w/o 12V Plug	•	•	•	•	•
Workstation w/12V Plug	•	•	•	•	•
Panel Carrier	N/A	•	•	•	•
Quik Welder® by Miller®	•	•	•	•	•
Pipe Racks	N/A	•	•	•	•
Vise	N/A	N/A	N/A	•	•
Electrician's Tree	•	•	•	•	•



Electric Powered Aerial Work Platforms

SPECIFICATIONS

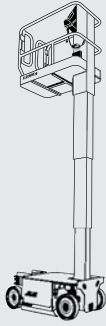

1230ES

1230ES Electric Mast Lifts

Platform Height	12 ft (3.66 m)
Platform Capacity—Unrestricted	500 lb (227 kg)
Platform Size	27 x 49.5 in. (0.68 x 1.25 m)
Overall Width	30 in. (76 cm)
Weight	1,740 lb (790 kg)
Power Source	4 x 6V 220 amp-hr

Main Features

- Maintenance-free elevating mast design—No chains, cables or rollers to grease or adjust.
- Only four hydraulic hoses—Less to maintain, minimizes leak potential.
- Compact dimensions and low GVW—Fits on most elevators.

Available Options

1000 Watt—AC Inverter/Charger	•
Flashing Amber Beacon	•

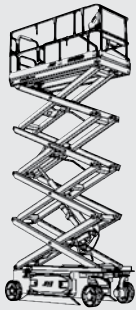

1930ES

2030ES

2630ES

2646ES

3246ES

ES Series Electric Scissor Lifts

	1930ES	2030ES	2630ES	2646ES	3246ES
Platform Height	18 ft 9 in. (5.72 m)	20 ft (6.10 m)	25 ft 6 in. (7.77 m)	26 ft (7.92 m)	31 ft 9 in. (9.68 m)
Platform Capacity—Unrestricted	500 lb (227 kg)	800 lb (363 kg)	500/800 lb (227/363 kg)	1,000 lb (454 kg)	700/1,000 lb (318/454 kg)
Platform Size	30x73.5 in. (0.76x1.87m)	30x90.5 in. (0.76x2.3 m)	30x90.5 in. (0.76x2.3 m)	44x98.5 in. (1.12x2.5 m)	44x98.5 in. (1.12x2.5 m)
Overall Width	30 in. (76 cm)	30 in. (76 cm)	30 in. (76 cm)	46 in. (1.17 m)	46 in. (1.17 m)
Weight	2,750 lb (1,247 kg)	3,750 lb (1,700 kg)	4,750 lb (2,155 kg)	4,770 lb (2,163 kg)	4,780 lb (2,168 kg)
Power Source	4 x 6V 220 amp-hr	4 x 6V 220 amp-hr	4 x 6V 220 amp-hr	4 x 6V 220 amp-hr	4 x 6V 220 amp-hr

Main Features

- Best on-the-job performance—Double duty cycles for longer operating times, tight turning radius for maneuvering and positioning, and a rugged design.
- Narrow aisle models—Efficiently access hard-to-reach areas for more productive maintenance projects.
- Revolutionary new Workstation in the Sky® options and accessories.

Available Options

1000 Watt—AC Inverter/Charger	•	•	•	•	•
Flashing Amber Beacon	•	•	•	•	•
Spring-Loaded Gate	•	•	•	•	•
245 Amp-Hour Batteries	○	•	•	•	•
AGM Batteries	•	•	•	•	•
Lifting Lugs	•	•	•	•	•
UL® EE Rating	•	•	•	•	•
Platform Padding	•	•	•	•	•
Platform Padding with Proximity Switches	•	•	•	•	•
1/2 in. Air Line to Platform	•	•	•	•	•
Nite Bright	•	•	•	•	•

Electric Powered Aerial Work Platforms SPECIFICATIONS

	3369LE	4069LE
LE Series Large Electric Scissor Lifts		
Platform Height	33 ft (10.06 m)	40 ft (12.19 m)
Platform Capacity—Unrestricted	1,000 lb (454 kg)	800 lb (363 kg)
Platform Size	65 x 115 in. (1.65 x 2.92 m)	65 x 115 in. (1.65 x 2.92 m)
Overall Width	5 ft 9 in. (1.75 m)	5 ft 9 in. (1.75 m)
Weight	9,760 lb (1,247 kg)	10,560 lb (4,790 kg)
Power Source	8 x 6V 370 amp-hr	8 x 6V 370 amp-hr

Available Options

110V-AC Power Pack Inverter	•	•
Flashing Amber Beacon	•	•
Hydraulic Leveling Jacks	•	•
Platform Worklights	•	•
Self-Closing Entry Gate	•	•
Tires—Foam-Filled Sand/Turf	•	•
1/2 in. Air Line to Platform	•	•
Top Rail Padding	•	•
Rail and Deck Padding	•	•
Bio-Degradable Hydraulic Oil	•	•
JLG QuikCharge Gen Set	•	•

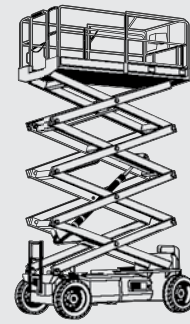

Main Features

- Double the duty cycles of competitive electric scissor lifts.
- Superior off-slab performance—Full-time automatic traction control system, standard oscillating axle, and all-terrain tires.
- Powerful options—QuikCharge GenSet and all-wheel drive.
- Fold-down handrails.

	T350	T500J
Towable Boom Lifts		
Platform Height	35 ft (10.67 m)	50 ft (15.24 m)
Platform Capacity	500 lb (227 kg)	500 lb (227 kg)
Horizontal Outreach	20 ft 2 in. (6.14 m)	31 ft 6 in. (9.6 m)
Overall Width	4 ft 9 in. (1.44 m)	5 ft 7 in. (1.7 m)
Weight	3,400 lb (1,542 kg)	4,800 lb (2,177 kg)
Power Source—Electric	24V DC, 4 x 6V 220 amp-hr	24V DC, 4 x 6V 220 amp-hr
Gasoline Engine—Optional	Honda GX 270	Honda GX 270

Available Options

Platform Rotator	•	•
Material Hook—500 lb capacity	•	•
Platform Mounted Glass/Panel Tray	•	•
Non-Marking Outrigger Pads	•	•
Spare Tire—Full Size	•	•
Flashing Amber Beacon	•	•
Lifting Lugs	•	•
2,500 Watt Generator	•	•



Main Features

- 35 ft (10.4 m) and 50 ft (15.2 m) models.
- Hydraulic auto-leveling outriggers for faster and easier set-up.
- 24V DC electric or gasoline powered engine.
- Platform controls with one-hand operation of boom functions.
- Accessory Mounting Tray accommodates customer provided generator, air compressor or pressure washer.
- Standard air and water lines to the platform.
- Optional Drive and Set from the platform.

Electric Powered Aerial Work Platforms

SPECIFICATIONS



Main Features

- 4 ft (1.22 m) articulating jib with optional JibPLUS®.
- ATC (Automatic Traction Control) improves performance on uneven surfaces.
- Ultra compact width of only 48 in. (1.22 m).
- Fast cycle times.

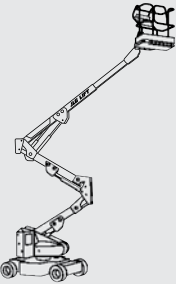

Main Features

- JibPLUS® models provide access in and around confined work areas.
- 4 ft 11 in. narrow chassis model for maneuvering in narrow aisles and confined areas.
- ATC (Automatic Traction Control) improves performance on uneven surfaces.
- QuikCharge GenSet option provides automatic charging for continuous machine operation.

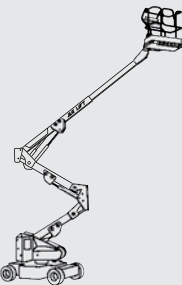

Main Features

- The fastest boom speeds in this class.
- ATC (Automatic Traction Control) improves performance on uneven surfaces.
- QuikCharge GenSet option provides automatic charging for continuous machine operation.
- Jib models provide access in and around confined work areas.

	E300AJ	E300AJP
E300 Series Electric Boom Lifts		
Platform Height	30 ft 2 in. (9.19 m)	29 ft 5 in. (8.96 m)
Platform Capacity—Unrestricted	500 lb (227 kg)	500 lb (227 kg)
Horizontal Outreach	20 ft 3 in. (6.17 m)	20 ft 1 in. (6.14 m)
Up and Over Height	13 ft 2 in. (4.01 m)	13 ft 2 in. (4.01 m)
Overall Width	48 in. (1.22 m)	48 in. (1.22 m)
Weight	15,060 lb (6,831 kg)	15,400 lb (6,985 kg)
Power Source	48V DC 8 x 6V 305 amp-hr	48V DC 8 x 6V 305 amp-hr

Available Options Include

Platform Worklights	•	•
Mesh to Top Rail Bolt-On Aluminum	•	•
1/2 in. Air Line to Platform	•	○
1200 Watt Inverter	•	•
UL® EE Rating	•	•
370 amp-hr Batteries	•	•

	E400A Narrow M400A Narrow	E400AJP M400AJP	E400AJP Narrow M400AJP Narrow
E400/M400 Series Electric Boom Lifts			
Platform Height	40 ft (12.19 m)	40 ft (12.19 m)	40 ft (12.19 m)
Platform Capacity—Unrestricted	500 lb (227 kg)	500 lb (227 kg)	500 lb (227 kg)
Horizontal Outreach	21 ft 2 in. (6.45 m)	22 ft 5 in. (6.83 m)	22 ft 5 in. (6.83 m)
Up and Over Height	21 ft 6 in. (6.55 m)	21 ft 6 in. (6.55 m)	21 ft 6 in. (6.55 m)
Overall Width	4 ft 11 in. (1.50 m)	5 ft 9 in. (1.75 m)	4 ft 11 in. (1.50 m)
Weight—M Models, add 300 lb (136 kg)	13,100 lb (5,942 kg)	13,700 lb (6,214 kg)	14,900 lb (6,759 kg)
Power Source	48V DC 8 x 6V 370 amp-hr	48V DC 8 x 6V 370 amp-hr	48V DC 8 x 6V 370 amp-hr
Generator Set—M models	45 amp Kubota	45 amp Kubota	45 amp Kubota

Available Options Include

Padding for Platform	•	•	•
Light Package	•	•	•
UL® EE Rating	○	•	○
1200 Watt Inverter	○	•	○
Mesh to Top Rail—Bolt-on Aluminum	•	•	•

	E450A	M450A	E450AJ	M450AJ
E450 Series Articulating Boom Lifts				
Platform Height	45 ft (13.72 m)	45 ft (13.72 m)	45 ft (13.72 m)	45 ft (13.72 m)
Platform Capacity—Unrestricted	500 lb (227 kg)	500 lb (227 kg)	500 lb (227 kg)	500 lb (227 kg)
Horizontal Outreach	23 ft 1 in. (7.04 m)	23 ft 1 in. (7.04 m)	23 ft 9 in. (7.24 m)	23 ft 9 in. (7.24 m)
Up and Over Height	24 ft 7 in. (7.49 m)	24 ft 7 in. (7.49 m)	25 ft 3 in. (7.7 m)	25 ft 3 in. (7.7 m)
Overall Width	5 ft 9 in. (1.75 m)	5 ft 9 in. (1.75 m)	5 ft 9 in. (1.75 m)	5 ft 9 in. (1.75 m)
Weight	12,600 lb (5,715 kg)	12,900 lb (5,851 kg)	14,400 lb (6,532 kg)	14,700 lb (6,667 kg)
Power Source	48V DC 8 x 6V 370 amp-hr	48V DC 8 x 6V 370 amp-hr	48V DC 8 x 6V 370 amp-hr	48V DC 8 x 6V 370 amp-hr
Generator Set—M models	45 amp Kubota	45 amp Kubota	45 amp Kubota	45 amp Kubota

Available Options Include

Fall Arrest Platform 36 x 72 in. (0.91 x 1.83 m)	•	•	•	•
Padding for Platform	•	•	•	•
Solid Non-Marking Tires	•	•	•	•
UL® EE Rating	•	○	•	○
1200 Watt Inverter	•	○	•	○

Electric Powered Aerial Work Platforms SPECIFICATIONS

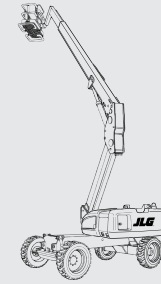

	E600J	M600J	E600JP	M600JP
E/M600 Electric Boom Series				
Platform Height	60 ft 3 in. (18.36 m)	60 ft 3 in. (18.36 m)	60 ft 4 in. (18.39 m)	60 ft 4 in. (18.39 m)
Platform Capacity—Unrestricted	500 lb (227 kg)	500 lb (227 kg)	500 lb (227 kg)	500 lb (227 kg)
Horizontal Outreach	43 ft 3 in. (13.18 m)	43 ft 3 in. (13.18 m)	44 ft 5 in. (13.54 m)	44 ft 5 in. (13.54 m)
Overall Width	7 ft 11 in. (2.41 m)	7 ft 11 in. (2.41 m)	7 ft 11 in. (2.41 m)	7 ft 11 in. (2.41 m)
Weight	15,200 lb (6,895 kg)	15,500 lb (7,031 kg)	15,750 lb (7,144 kg)	16,050 lb (7,280 kg)
Power Source	48V DC, 8 x 6V 415 amp-hr	48V DC, 8 x 6V 415 amp-hr	48V DC, 8 x 6V 415 amp-hr	48V DC, 8 x 6V 415 amp-hr
Generator Set—M models		45 amp Diesel Kubota		45 amp Diesel Kubota

Available Options

30 x 48 in. (0.76 x 1.22 m) Platform	•	•	•	•
Fall Arrest Platform 36 x 72 in. (0.91 x 1.83 m)	•	•	•	•
Mesh to Top Rail Bolt-on Aluminum	•	•	•	•
Soft Touch System 6 ft Platform Padding (30 x 72 in. Platform)	•	•	○	○
1/2 in. Air Line to Platform	•	•	•	•
Foam-Filled Tires	•	•	•	•
1200 Watt Inverter	•	•	•	•
Hostile Environment Kit ¹	•	•	•	•
UL® EE Rating	•	○	•	○
Tow Package ²	•	•	•	•
Light Package ³	•	•	•	•
Platform Worklights	•	•	•	•
Flashing Amber Beacon	•	•	•	•

1. Includes console cover, boom wipers and cylinder bellows. 2. 2WD only. 3. Includes head and tail lights and platform work lights.

Main Features

- The world's first and only 60-foot Electric Boom—Indoor and outdoor versatility.
- Indoor advantages—Zero emissions, industry-leading noise reduction, non-marking tires and the lowest weight in its class.
- Outdoor advantages—Rugged design with all-wheel drive, automatic traction control and oscillating axle.
- Available with 45 amp Kubota diesel-powered generator to maintain battery charge level during extended outdoor use.

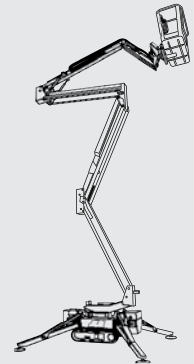

	X390AJ	X550AJ	X700AJ
Compact Crawler Series Boom Lifts			
Platform Height	39 ft 2 in. (11.9 m)	55 ft (16.76 m)	64 ft 7 in. (21.2 m)
Platform Capacity	440 lb (200 kg)	440 lb (200 kg)	440 lb (200 kg)
Horizontal Reach	22 ft (6.7 m)	21 ft (6.4 m)	69 ft 7 in. (21.2 m)
Overall Width	31 in. (77 cm)	31 in. (77 cm)	39 in. (99 cm)
Weight	3,682 lb (1,670 kg)	4,630 lb (2,098 kg)	6,592 lb (2,990 kg)
Power Source			
Gasoline Engine	Honda GX270 9 hp (6.7 kW) Honda iGX390 13 hp (9.7 kW)	Honda iGX440 15 hp (11.1 kW)	Honda iGX440 15 hp (11.1 kW)
Diesel Engine	Hatz 1B30 7 hp (5.22 kW)	Hatz 1B40 10 hp (7.46 kW)	Perkins 402.05 14 hp (10.44 kW)
Electric Engine	90Ah 48V Lithium-Ion	90Ah 48V Lithium-Ion	90Ah 70V Lithium-Ion

*Certain options of country standards increase weight. Preliminary specifications -- consult factory for details.

	T20E*	T26E	E33MJ
Toucan Series Mast-Style Boom Lifts			
Platform Height	20 ft 2 in (6.14 m)	26 ft 5 in. (8.1 m)	32 ft 9 in. (9.98 m)
Platform Capacity—Unrestricted	500 lb (227 kg)	500 lb (227 kg)	500 lb (227 kg)
Horizontal Reach	6 ft 6.7 in (1.99 m)	8 ft 8 in. (2.64 m)	14 ft 6 in. (4.42 m)
Overall Width	39 in. (99 cm)	45 in. (114 cm)	47.2 in. (120 cm)
Weight	5,360 lb (2,431 kg)	6,834 lb (3,100 kg)	11,574 lb (5,250 kg)
Power Source	24V DC 225 amp-hr	24V DC 240 amp-hr	24V DC 930 amp-hr

Available Options

1/2 in. Air Line to Platform	•	○	○
Platform Worklights	•	•	•

*Coming mid 2011

Main Features

- Low weight and rubber tracks for enhanced maneuverability and accessibility.
- Compact design increases ease of transport.
- Electric and combustion combination power for efficient energy usage.



Main Features

- Versatile articulating jib provides up to 14 ft 6 in. (4.42 m) up and over reach.
- 360-degree rotating mast for unmatched positioning capabilities.
- Capacity for two workers and supplies.
- Drive through doorways and narrow aisles.
- Navigate around multiple obstacles on the ground and in the air.

JLG Industries, Inc.
1 JLG Drive
McConnellsburg, PA 17233-9533
Telephone 717-485-5161
Toll-free in US 877-JLG-LIFT
Fax 717-485-6417
www.jlg.com
An Oshkosh Corporation Company

Form No.: ELEAWP-BRO-0208
Part No.: 3131565
R041107
Printed in USA

